



9:41 AM

Tracer SC



Tracer SC

home alarms user... configuration... help

Trends and Gauges

EQUIPMENT OPERATION



Outside Air Flow

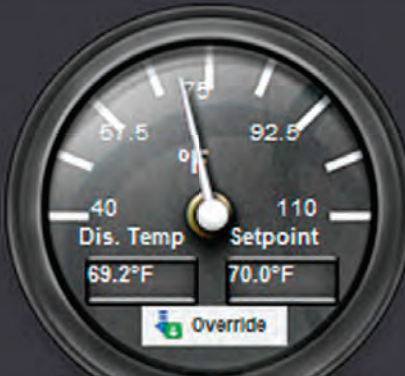

Discharge Air Temp



Discharge Air Press

INTELLIPAK OPERATING PARAMETERS

Occupancy: Occupied

Mode: Cool

Intelligent Variable Air

An EarthWise™ System from Trane
for packaged DX applications



EarthWise™ Systems are good for business

System overview

p. 3

System benefits

p. 4

System components

p. 7

System controls

p. 8

Optimized system control strategies

p. 10

Control dashboards

p. 14

Trane Intelligent Services

p. 16

Equipment

p.18

Pre-packaged equipment controls

p. 22

Design strategies

p.24

Design resources

p. 28

Retrofits

p. 30

Trane EarthWise Systems are comprehensive approaches to HVAC system design that support what is best for the building, right for the environment and good for business.

The United States Environmental Protection Agency identified four critical attributes for HVAC systems: higher efficiency, lower overall emissions, with documented and sustainable performance. Trane EarthWise Systems deliver all four by leveraging high-efficiency HVAC equipment and pre-packaged advanced controls to optimize whole system design and operation.

Higher efficiency. With higher energy costs on the horizon, building owners should be making plans to mitigate the impact on operating expenses. An obvious place to start is with one of the biggest energy consumers in the building: the HVAC system. EarthWise Systems reduce energy costs associated with comfort cooling and heating, and ensure that your system complies with all applicable codes and standards.

Low emissions. Efficiency leads to low emissions, both from direct and indirect sources at the building site and back at the power plant. Using well-designed products and construction methods aimed at creating tight systems, direct emissions are kept to a minimum. Efficient EarthWise System designs and optimized control strategies keep the indirect emissions at the power plant to a minimum.

Documented. Designing and operating for code compliance can be a daunting task.

It's critical that your system not only meet the requirements, but also document your compliance. EarthWise Systems pre-packages many code-mandated control requirements into Trane's Tracer™ controls, simplifying code compliance and documentation.

Sustainable. EarthWise Systems deliver operational efficiencies that support sustainable building performance and make it easy to do the right thing for your building, the environment and your bottom line.

"The communication, the organization, just the way they approached the job were terrific. Peace of mind is something I look for, and Trane gives it to me."

— Larry Drill, Drill Construction Company
Municipal Square Associates managing agent

EarthWise™ Intelligent Variable Air System

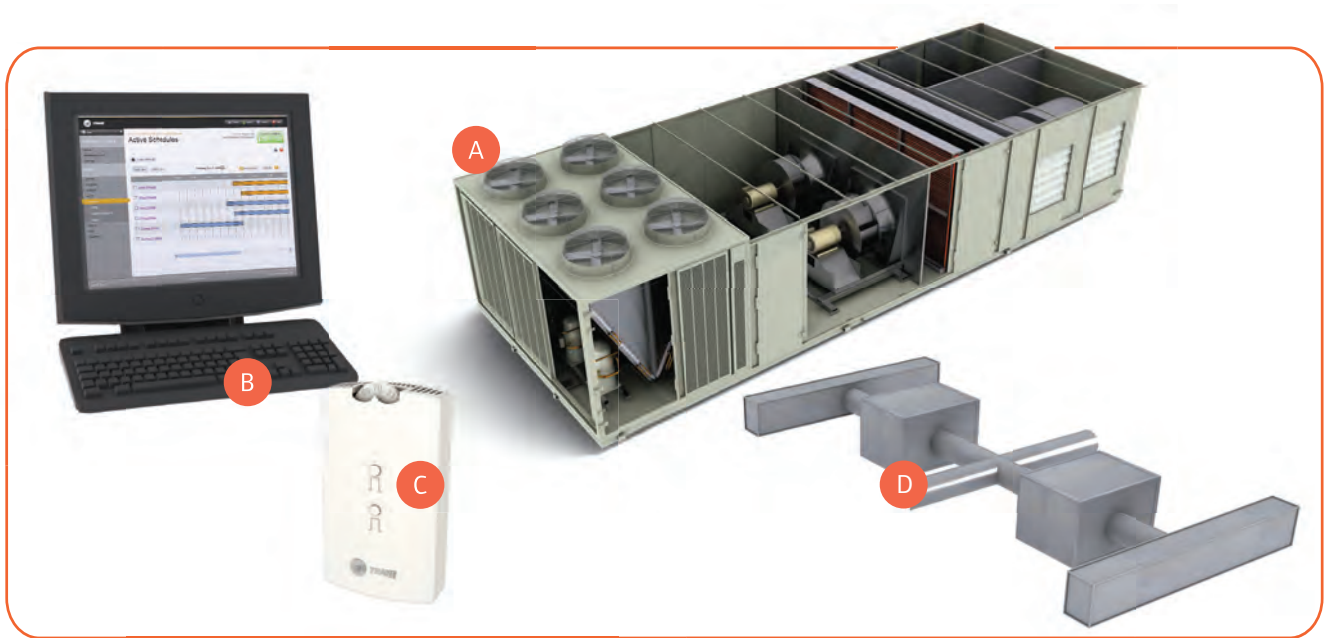

The EarthWise Intelligent Air System for packaged DX applications

A pre-packaged, variable-air HVAC system design concept that:

- Provides heating, cooling, and ventilation for multiple zones,
- Is 20 percent to 30 percent more efficient than traditional VAV systems, and
- Delivers high performance that is sustained by interactive operator dashboards and real-time analytics.

More information can be found at
www.trane.com/EarthWise

- A Trane IntelliPak™ rooftop units** provide high efficiency and cost effectiveness with pre-packaged, factory-installed controls. Factory-installed options include exhaust air energy recovery, outdoor airflow measurement, evaporative condensing, variable-speed compressors and fans, and a variety of filter options.
- B Tracer™ system controllers** add a layer of sophistication and turn a common VAV system into an Intelligent Variable Air System. Factory-installed programming, start-up and commissioning coordination, wired or Wireless Comm, and dashboards lead to easy installation and operation.
- C Wired or wireless zone sensors** communicate with the controller on the VAV terminal to maintain proper space conditions.
- D Trane VAV terminal units** offer low leakage, tested, repeatable performance and pre-packaged, factory-installed controls.

Established performance, enhanced with new technology

Variable air systems have a proven track record of reliable, efficient performance. Using new design strategies and advanced technologies, Trane EarthWise™ Intelligent Variable Air systems are more efficient than traditional VAV systems.

Twenty to thirty percent more efficient.

Through advanced technologies— including energy recovery and variable-speed equipment — and optimized controls, Trane Intelligent Variable Air systems can be 20 percent to 30 percent more efficient than traditional VAV systems. User-friendly dashboards allow you to easily monitor that efficiency to help maintain peak performance for the life of the system. Based on countless new buildings, retrofits and recommissioning projects, we know that properly designed and controlled VAV systems are attainable, and can have lower installed and operating costs than alternative systems.

As with every EarthWise System, Trane provides, supports, and encourages energy modeling during the system design phase. Trane Air-conditioning Economics (TRACE™) software can be used to determine how this system can help your building earn high performance designation, including earning LEED® points under EAc1.

Efficiencies in energy, cost and time.

Trane's EarthWise Intelligent Variable Air System was created to simplify the design and implementation of a high-performing HVAC system. The system's controls are baseline programmed at the factory to contribute to smooth installation and

commissioning, and avoid the inconsistencies of custom programming — but still provide on-site programming flexibility for project-specific requirements. Standard apps and operator dashboards, supported by thorough documentation, take the mystery out of how your system works, so that you and Trane can keep it running optimally over the system's lifetime.

The packaged version of the Intelligent Variable Air System includes eighteen standard configurations for Trane IntelliPak™ units, air terminal devices and system controls. Identifying the repeatable aspects of these system designs allows us to deploy standardized, pre-packaged control sequences, drawings and operator graphics and dashboards.

Comfort control. Variable air systems are capable of controlling the temperature in many zones with dissimilar cooling and heating requirements. This is accomplished by providing a VAV terminal unit and temperature sensor for each independently controlled zone.

High indoor air quality. For most applications, the foundation of good IAQ is proper ventilation. The Intelligent Variable Air System balances energy efficiency and IAQ by bringing in no more than the required amount of outdoor air for ventilation, at all operating conditions, through the use of optimized ventilation control strategies and flow-measuring Traq™ outdoor-air dampers. Building pressurization control not only saves energy, it also reduces infiltration, which can lead to moisture-related problems in the building envelope.

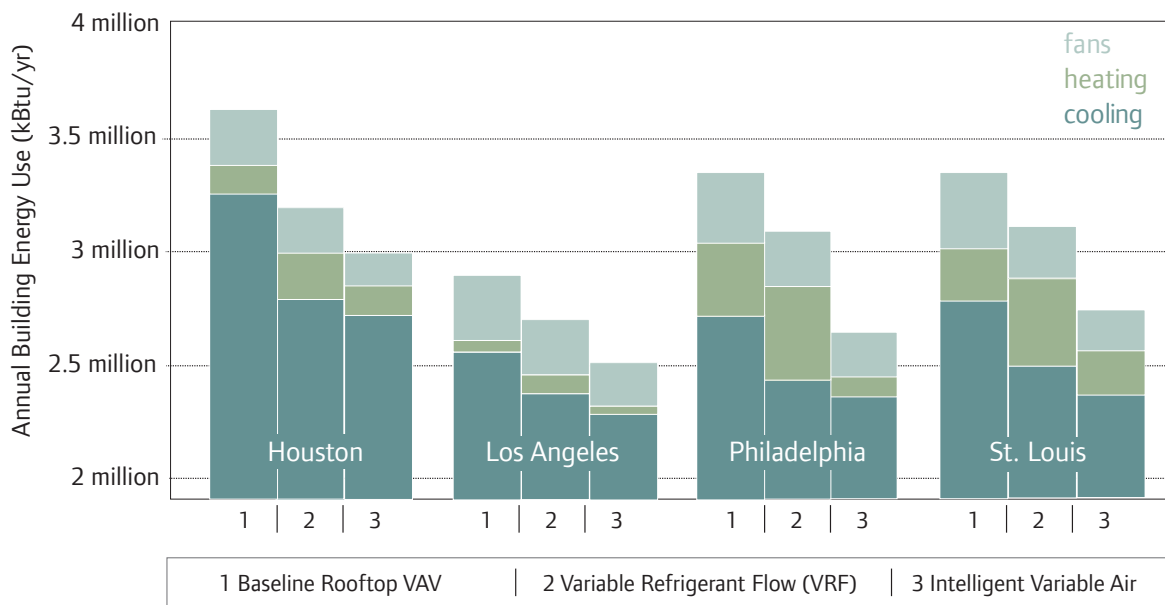

Annual energy use for an 89,000 ft² office building, estimated using Trane TRACE™ building energy analysis software. The baseline rooftop VAV system is modeled according to Appendix G in ASHRAE Standard 90.1-2007.

Low installation costs. Ventilating and cooling or heating with the same system naturally costs less to install—only one set of distribution piping and/or ductwork is required.

Using a centralized system allows the system to be sized for “block” load, that is, the highest heating or cooling load observed at one time. Individual zone-based systems will naturally have more installed capacity because they are sized on the “sum of the peaks.”

By using cold air, fans and ductwork can be right sized in a modest trade-off with energy costs.

Code compliant. Complying with codes and documenting that compliance is easier when using an engineered system from Trane. Code-mandated system control requirements are pre-packaged in the standard Trane IntelliPak™ and Tracer™ controllers. These routines and their interfaces are flexible, yet standardized to help reduce opportunities for errors and reduce the need for custom programming.

High-performance building designation steers the discussion toward systems that have lower energy costs. The EarthWise Intelligent Variable Air system, using the design and operation strategies identified in this catalog, can help earn LEED points under EAc1, depending on the baseline system and local utility rates.

Efficient, flexible, comfortable, and now, even better

VAV systems have always been comfortable and flexible—adapting automatically to building load changes over time. But beneath that comfort, outdated controls and system components were likely wasting energy. The Intelligent Variable Air system makes it easy to keep the comfort while minimizing energy waste.

Zone and system controls, simplified.

Controls for a high performance, multiple-zone VAV system require more coordination than controls for a single-zone system. This is one of the driving forces behind the need for a repeatable, highly configured yet standardized system control. These controls ensure that the inherent benefits of the system do not come at an energy cost or contribute to a poorly performing system.

Reduced reheat. One of the traditional complaints about multiple zone VAV systems is that for some zones, they heat air that has been previously cooled with mechanical cooling. Judicious use of ventilation optimization, supply air temperature reset and parallel fan powered VAV terminals can keep this to a minimum.

Efficient central fan operation. Another opportunity to save energy is in the central fan(s) delivering cooling and ventilation together. The central fan(s) must continue to operate, even when the spaces are unoccupied and do not need to be ventilated. However, proper scheduling, optimized ventilation control, and an “occupied standby” mode minimize fan and ventilation energy when some zones require

ventilation while others do not. A dedicated ventilation system has to run when just one zone needs ventilation, because it typically doesn’t have zone dampers for reducing ventilation to a minimum when the zone is unoccupied. See sidebar for potential code issues.

Ventilation efficiency. VAV systems using a single supply duct typically deliver a mixture of recirculated air and outdoor air—the same fraction of outdoor air is delivered to all zones. While this may be sufficient ventilation for some zones, depending on each zone’s cooling or heating load, it may not be enough for others. ASHRAE Standard 62.1 for indoor air quality requires that the system bring in more outdoor air in order to satisfy the zone needing the highest fraction of ventilation air, with compensation for overventilation in the recirculated air. This leads to all other zones being over-ventilated and extra energy to condition the additional outdoor air.

System controls from Trane automatically solve the equations found in ASHRAE Standard 62.1, and allow the system to optimize ventilation by dynamically changing outdoor air damper position in response to the needs of the critical ventilation zone(s). This can allow the system to ventilate to mechanical code requirements without an unnecessarily high, fixed outdoor air damper position. A further refinement of this control allows the system to automatically open the zone damper in the critical ventilation zone(s), increasing reheat slightly, in exchange for a reduction in outdoor air at the system level. This is permitted by the ASHRAE 90.1 energy code.

Did you know?

A recent interpretation from ASHRAE Standard 62.1 clarifies that zones must continue to receive the building component ventilation rate (Ra) whenever they are *expected* to be occupied, even when they are temporarily unoccupied.

Intelligent Variable Air System components



Tracer™ SC system controller

- Standard, pre-packaged applications and optimized system control sequences
- Easy-to-use interfaces with high-quality graphics
- Optimized for the mobile world
- Wired or Wireless Comm
- Interactive operator dashboards depict system operation and document energy savings
- Identify efficiency improvement opportunities through Trane Intelligent Services



IntelliPak™ rooftop unit

- Outdoor airflow measurement with Traq™ dampers
- Energy-optimized fan solutions
- Options for total-energy wheel, evaporative condensing, and various levels of filtration
- IntelliPak controller with pre-packaged control sequences and wired or Wireless Comm



VariTrane™ VAV terminals

- Accurate flow measurement and rugged construction
- Factory-commissioned Tracer™ UC210 or UC400 controller with pre-packaged control sequences and wired or Wireless Comm
- Retrofit (RIRO) dampers available for upgrading older, existing systems



Zone sensors

- Wired or wireless models
- Options for digital display, setpoint override, or occupancy override

System controls

The Intelligent Variable Air System’s controls are baseline programmed at the factory to contribute to smooth installation and commissioning, and avoid the inconsistencies of custom programming — but still provide on-site programming flexibility for project-specific requirements.

Tracer™ SC standard applications. The Tracer SC system controller provides many of the coordinating and optimization functions for the system, through the use of these standard applications:

AREA is the application used to define groups of zones, which can be dictated by the physical layout (office groupings, walls, etc.) and the logical layout (tenants, departments, etc.) of the building. Zones are assigned to an area to enable coordinated control and prevent heating and cooling systems from “fighting” each other.

VAS is a virtual representation of the physical equipment in the building. The Tracer Variable Air System (VAS) application coordinates the operation of the packaged DX rooftop unit with the connected VAV terminals, ensuring safe, efficient, and reliable performance during the various operating modes. It also optimizes the performance of the system using data gathered from the individual VAV terminals, and can be used to periodically commission the VAV terminal units to ensure that each one is operating properly.

Schedules are time-based controls. Tracer SC integrates schedules with the Area and VAS applications to define the desired operating mode of the HVAC equipment based on time, temperature and humidity. Operating modes typically include occupied, unoccupied, optimal start and stop, humidity pull down, and night purge. Mode charts (like the one shown on the opposite page) explain what the various components of the system are doing during each operating mode.

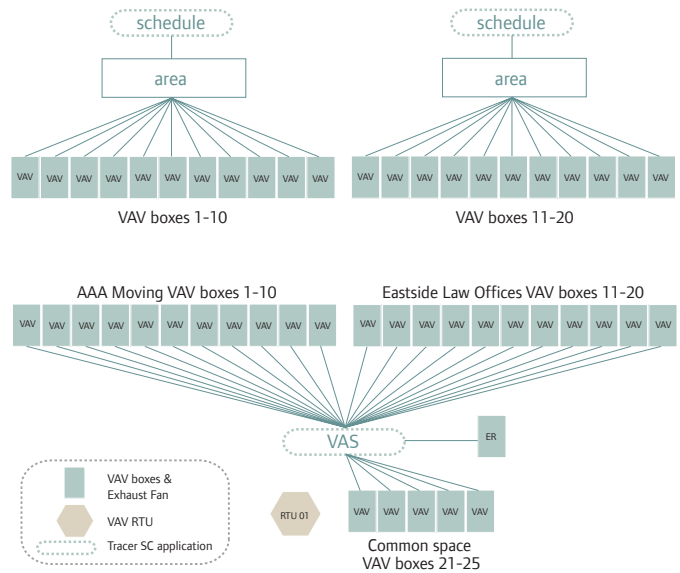

Easily understood interfaces



Floor plan graphics



Mobility and accessibility of Tracer™ SC.

Tracer SC delivers the industry’s most intuitive user interface, and provides you access to the system no matter where you are, on any connected device. And it is so much more than simple web connectivity. We have optimized our interfaces for the mobile world, so the intuitive and easy to use nature of our systems translates seamlessly from a workstation, to a tablet or smart phone.

Ease of implementation. Setting up schedules, areas and VAS are accomplished through the Tracer SC standard graphical interface using setup “wizard” routines, autodiscovery, drop-down selections and check boxes, not custom programming.

The EarthWise Intelligent Air System makes the controls setup even easier and more standardized, with more programming installed at the factory.

Wireless controls. Trane Wireless Comm eliminates the wire between equipment and system controllers for Tracer™ building automation systems supporting BACnet™ standard protocol, and provides wireless connectivity to zone temperature sensors. The benefits include faster project completion, less disruption to building occupants, increased location flexibility, and life-cycle savings due to easier relocation when space layout or use changes in the future.

Through use of self-healing wireless mesh, extended signal range, and conformance to the ZigBee™ Building Automation standard, Trane Wireless Comm provides reliable, expandable operation for the life of the building.

Mode chart

Mode	Supply Fan	RTU OA Damper	VAV Boxes Damper	Heat Source
Occupied	Modulate to maintain static pressure SP	Modulate to maintain minimum OA SP. If econ is enabled - modulate to maintain DAT SP	Modulate to maintain flow SP (occupied zones)	Modulate to maintain zone temp SP (occupied zones)
Unoccupied	Off	Closed	Closed	Off/Closed
Unoccupied Heat/Cool	Modulate to maintain static pressure SP	Closed If economizer is enabled - modulate to maintain DAT SP	Modulate to maintain flow SP (affected zones)	Modulate to achieve unoccupied heating SP + unoccupied differential (affected zones)
Unoccupied Humidify	Modulate to maintain static pressure SP	Closed	Modulate to maintain flow SP (affected zones)	Modulate to achieve unoccupied heating SP + unoccupied differential (affected zones)

Optimized system control strategies

To help achieve the 20 percent to 30 percent efficiency improvement, EarthWise™ Intelligent Variable Air Systems pre-package the following optimized system control strategies in Tracer™ system and equipment controls.

Fan-pressure optimization. As cooling loads change, the VAV terminals modulate to vary airflow supplied to the zones. This causes the pressure inside the supply ductwork to change. In many systems, the RTU controller varies the capacity of the supply fan to maintain static pressure in the ductwork at a constant setpoint. With this approach, however, the system usually generates more static pressure at part load than necessary.

When communicating controllers are used on the VAV terminals, it is possible to optimize this static pressure control function to minimize duct pressure and save fan energy. Tracer SC continually polls the individual VAV controllers, looking for the VAV terminal with the most-open damper. The duct static pressure setpoint for the supply fan is then dynamically reset to provide just enough pressure so that at least one damper is nearly wide open. At part-load conditions, the supply fan is able to operate at a lower static pressure, which results in less energy use, lower sound levels, and reduced risk of fan surge.

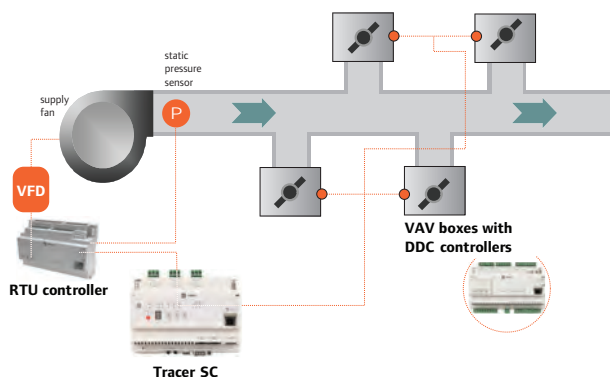

Supply-Air Temperature (SAT) reset. In a VAV system, increasing the SAT at part-load conditions can reduce cooling and reheat energy use, but increases fan energy and can result in elevated indoor humidity levels. Therefore, SAT reset should be implemented so that it minimizes overall system energy use, by considering the trade-off between compressor, reheat, and fan energy.

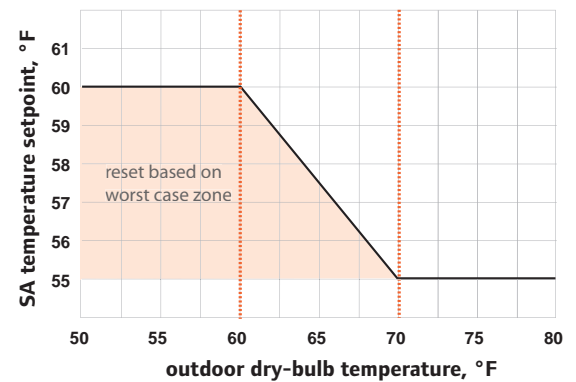

Tracer SC balances these competing issues by keeping the SAT setpoint cold when it is warm outside, thereby taking advantage of the significant energy savings from unloading the fan and avoiding elevated indoor humidity levels. The SAT setpoint is reset upward during mild and cold weather to enhance the benefit of the airside economizer (thereby saving cooling energy) and minimize reheat energy use. However, Tracer also monitors the current temperature and VAV damper position for each zone, and will lower the SAT setpoint if needed to prevent any zones from overheating.

Ventilation optimization. In a VAV system, the rooftop unit delivers fresh outdoor air to several, individually controlled zones. Demand-controlled ventilation (DCV) involves resetting intake airflow in response to variations in zone population. While commonly implemented using carbon dioxide (CO₂) sensors, occupancy sensors, or time-of-day (TOD) schedules can also be used.

Tracer SC optimizes the amount of ventilation in a multiple-zone VAV system by combining these various DCV strategies at the zone level (using each where it best fits) with ventilation reset at the system level. With this strategy, CO₂ sensors are installed only in those zones that are densely occupied and experience widely varying patterns of occupancy. Zones that are less densely occupied or have a population that varies only a little are probably better suited for occupancy sensors or a time-of-day schedule.

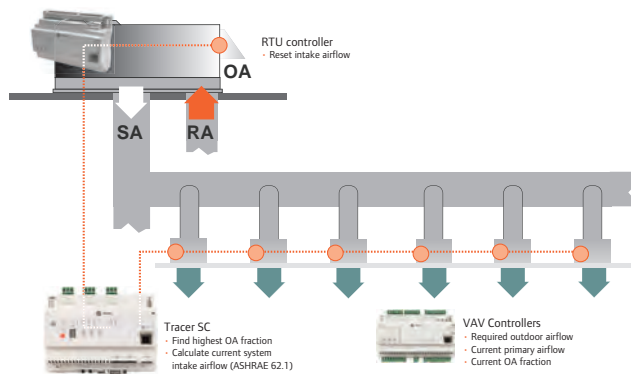

These various zone-level DCV strategies are used to reset the ventilation requirement for their respective zones for any given hour. In addition, the controller on each VAV terminal continuously monitors primary airflow being delivered to the zone and calculates the current OA fraction (Z_{pz}).

Then, Tracer SC periodically gathers this data from all VAV terminals and solves the ventilation reset equations (prescribed by ASHRAE Standard 62.1) to determine how

much outdoor air must be brought in at the rooftop unit to satisfy all zones served. Finally, Tracer sends this new outdoor airflow setpoint to the controller on the IntelliPak™ rooftop unit, which then modulates a flow-measuring (Traq™) outdoor-air damper to maintain this new setpoint.

This strategy reduces the energy required to condition outdoor air brought in for ventilation, while minimizing installed cost and risk by installing CO₂ sensors only in those zones where the payback is the greatest.

Optimal start/stop. In some buildings, a simple time clock or time-of-day schedule is used to start and stop the HVAC system. During hours when the building is expected to be unoccupied, the system is shut off and the temperature is allowed to drift away from the occupied setpoint. For most days of the year, the system starts much earlier than needed.

Tracer SC uses a strategy called optimal start, which determines the length of time required to bring each zone from current temperature to the occupied setpoint temperature. Then, Tracer waits as long as possible before starting, so that the temperature in each zone reaches occupied setpoint just in time for occupancy. This strategy reduces the number of system operating hours and saves energy.

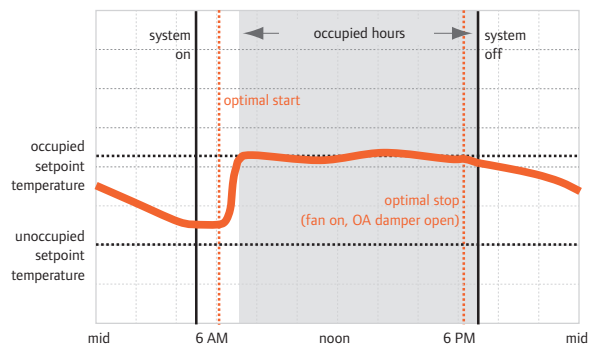

Energy-saving potential of optimized system controls.

There is a real potential to save energy in VAV systems through optimized system control strategies. The chart to the right shows the potential energy savings of using these optimized control strategies in an office building that has a typical VAV system. The optimized VAV system controls reduced HVAC energy use by 10 to 20 percent. This savings reduces operating costs for the building owner and can help in achieving points toward LEED® certification.

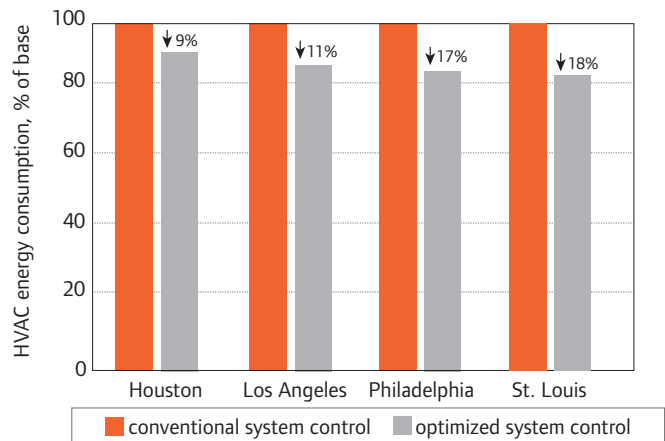

Implementing optimized controls.

Optimized control strategies, such as optimal start and stop, unoccupied economizing, fan-pressure optimization, and ventilation optimization, are pre-packaged in the Trane Tracer™ controllers. Others, such as supply air temperature reset and humidity pull-down, can be quickly implemented using standard code.

Many of these optimized control strategies are implemented by simply “checking the box” to enable a strategy, or to add or remove zones.

Wireless controls allow easier upgrade.

Wireless technology, retrofit dampers and pre-packaged controls are particularly well-suited for upgrading old pneumatic or non-communicating electronic controls to a data-rich, Intelligent Variable Air system with minimal occupant disruption (see pp. 30-31).

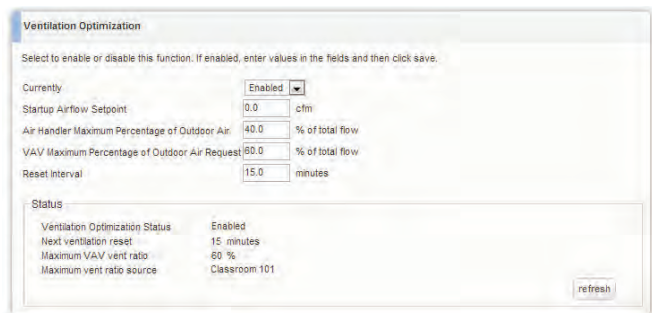
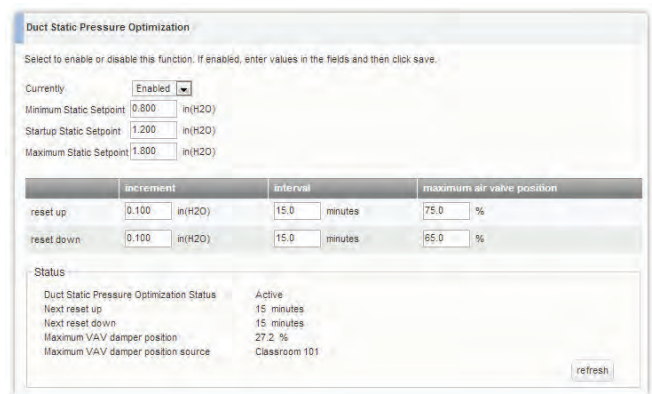

Sustaining performance. Tracer SC presents data as usable information with an intuitive user interface to help operators sustain building efficiency for the life of the system.

Removing overrides. “Temporary” changes to setpoints or operating schedules, when left in place long after the triggering event or condition, are another potential energy waste. Removing these overrides is often essential for the system to operate at a sustained high level of performance.

Tracer SC makes it easy to identify these overrides and remove them to return the system to normal operation.

“Rogue” zones. A zone that is often overheating or overcooling, due to either a faulty component or a design error, can limit the energy savings potential of using these optimized control strategies. If left unresolved, these “rogue” zones can lead to unnecessary cooling, heating, and fan energy use.

Tracer SC allows the operator to temporarily prevent these rogue zones from impacting the optimized control strategies, by simply unchecking a box in the user interface.

Through the Trane Intelligent Services system, detailed analytics help identify these “rogue” zones, and alert the building owner of the potential energy savings that would result from fixing the problem.

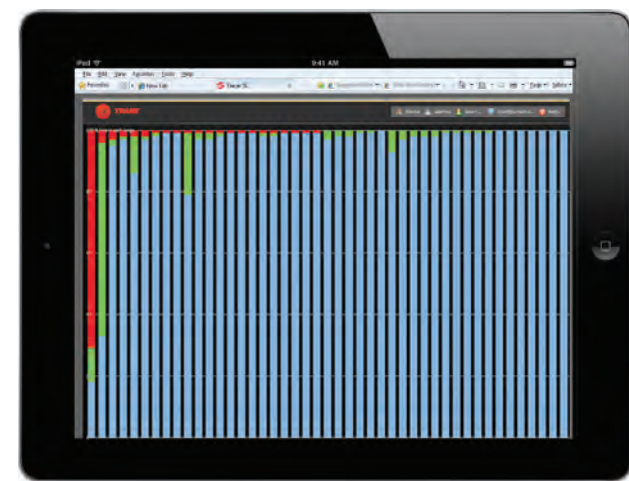
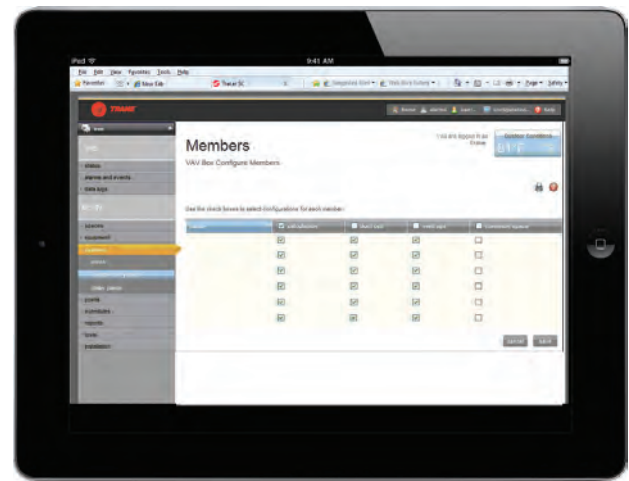

Intuitive, accessible dashboards



It's one thing for the controls installer to understand how to set up the system, but it's imperative that the operator understand how the system works. Standard apps and operator dashboards, supported by thorough documentation, take the mystery out of how your system works, so that you and Trane can keep it running optimally over the system's lifetime.

Dashboards are all about giving the operator information that is actionable—gauges with min and max values identified, warnings, alerts and error messages—helping identify opportunities to optimize system operation.

Tracer™ SC provides access to your system from any connected device: PCs, tablets, even smart phones.

Strategic data



At-a-glance gauges



Keeping custom design out of programming is key for creating systems that function the same from one job to the next - making it a lot easier to troubleshoot and sustain high performance over time. Configuration screens and scheduling applications are easy to use and understand.

Preprogrammed displays illustrate the energy being saved by optimal system control strategies.

These system savings calculations are suitable for a public display, for example as part of a lobby kiosk.

Configuration screen

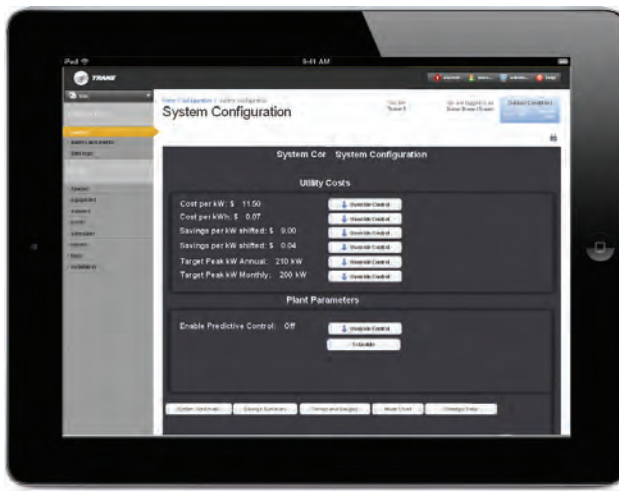

Scheduling application

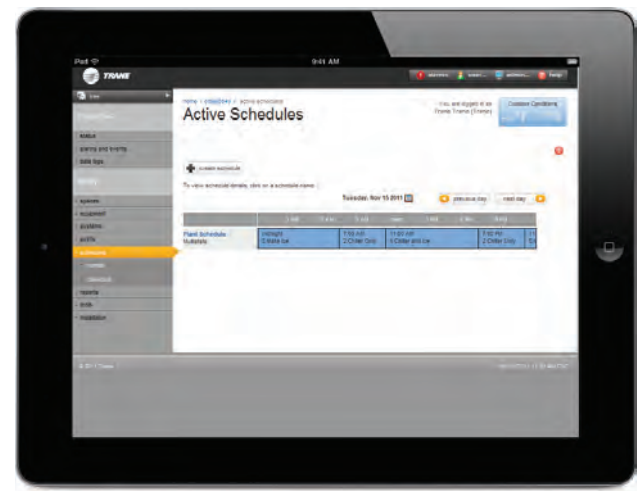

Performance summary



Savings calculations



Trane Intelligent Services (TIS)



TIS is the revolutionary integration of technology, proprietary analytics and Trane expertise that continuously collect, interpret and act on building data to improve the performance of the building's systems. When applied to an EarthWise™ Intelligent Variable Air System, TIS can help sustain the system's high level of performance for life.

Three service tiers are available: Alarm Notification (included with all Trane Service Agreements), Active Monitoring, and Building Performance.

Alarm Notification. (included with all Trane Service Agreements)

- Customer-defined data-collection points
- 24/7/365 automated alarm and event monitoring
- Automated notification via email, text or pager
- Archiving of critical alarm data
- Bi-monthly scheduled backup

Every notification is customized to meet the customer's needs, and assures that the right person is being alerted if there is a system malfunction. Immediate and timely notification allows you to take prompt action to resolve the problem and avoid interruptions in your operation. TIS offers customers peace of mind, knowing that the fully automated alarm system's responsiveness means they are never out of touch with the systems and working environment of their buildings.

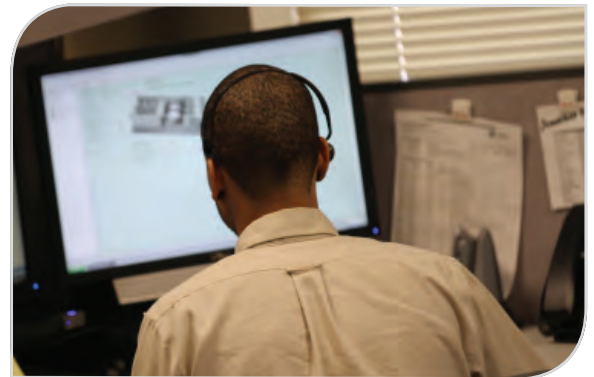

Alarm Notification let Honda Performance Development (HPD) staff know about an air conditioning problem in their server room and low air pressure in the facility's main air compressor. They design process relies on the servers, and the two large Ingersoll Rand compressing units are vital to product manufacturing. The Alarm Notification feature enabled the HPD staff to resolve both problems quickly with no design or equipment downtime. Instead of waiting for problems to become obvious, HPD manager Rick Walroth was happy to be ahead of the game.

"This is a great addition to have for the Tracer™ system." — Rick Walroth, Honda Performance Development



Active Monitoring includes Alarm Notification, plus the benefit of immediate diagnostic and responsive action capabilities.

- Diagnostics and alarm analysis by a technical specialist
- Off-site alarm mediation if possible
- Intelligent mobilization of local Trane authorized service personnel
- Alarm documentation and reporting (daily, weekly, monthly, quarterly)

Faster detection means faster resolution, saving critical time and money. Forty percent of the critical alarms are resolved within 30 minutes of the alarm sounding, which gets your system operational more quickly. Triple redundancy ensures your system and operations are safe and secure.

Building performance offering includes all of the features of Active Monitoring coupled with analyzed data and performance-driven recommendations and actions enabling high performance operating conditions.

- Initial system-wide assessment
- Continuous analysis by automated system analytics
- Results-oriented, value-based actionable recommendations
- On-going commissioning reporting to monitor parameters

The Building Performance level of TIS is intelligence in action—a warning when a system malfunctions and data translated into actionable solutions. Anticipating problems and proactively solving them dramatically reduces downtime and increases productivity. TIS is the customer’s safety net for occupant comfort and satisfaction. Savings are achieved through efficient, uninterrupted operation, restoring the building to high performance.

“The Trane Performance Based Agreement, coupled with Trane Central Monitoring, has significantly reduced our downtime by more than 60 percent and cut our truck rolls in half, which has improved response time and turnaround time on system repairs. With Trane Central Monitoring we’ve been able to maintain a 99 percent uptime commitment to our customers. Trane Central Monitoring is a critical tool in our business process to insure we meet our business demands. With my local Trane account manager I always know I am in good hands and that tasks will be done 100 percent of the time.” — Mark Manning, ARRIS Group

Equipment

IntelliPak™ rooftop unit

- A High-efficiency unit options:** AHRI certified CEE Tier 2 performance with highest standard unit performance in the industry
- B Traq™ flow-measuring outdoor air measurement station:** Accurate even at low flow and meets LEED® IEQ credit 1.
- C High-efficiency filter options:** Can accommodate up to MERV14 filters to help meet LEED IEQ credit 5
- D All aluminum microchannel condenser coil:** Qualifies for LEED EA credit 4 for refrigerant charge, aluminum minimizes corrosion
- E eFlex™ variable-speed compressor option:** Superior part load dehumidification control and highest energy efficiency
- F eDrive™ direct-drive plenum fan(s) option:** AHRI certified, higher efficiency with increased reliability and simplified installation
- G Optimized forward-curved fans:** Superior for low static, high airflow applications with wide selection flexibility
- H Piezometer on direct-drive plenum fans:** Measure supply airflow and coordinate with Traq damper to measure percent outdoor air
- I Double wall construction:** Improved rigidity and cleanability with additional insulation in the cold areas of the unit
- J Return and exhaust fan options with building pressure control:** Saves energy and protects the building by minimizing moisture-related envelope problems
- K Factory-installed DDC controls.** Pre-packaged sequences, wired or Wireless Comm

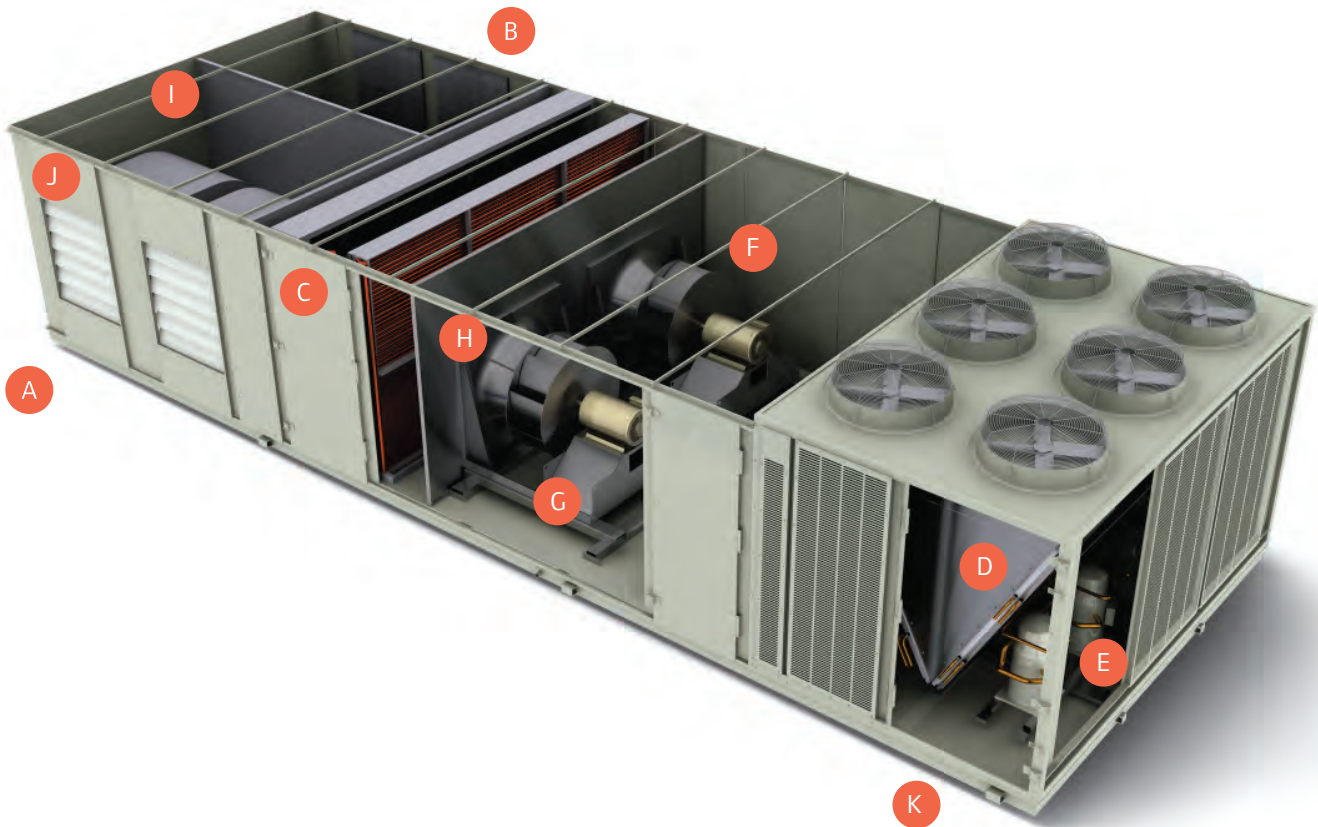

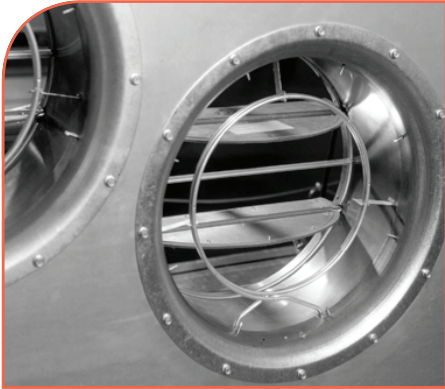

Outdoor air flow measurement

- Traq™ dampers maintain accuracy at low airflow ranges
- Factory-installed, -tested, and -verified performance
- Easily integrated flow measurement for optimizing ventilation control
- Code compliance documentation via measured outdoor air intake

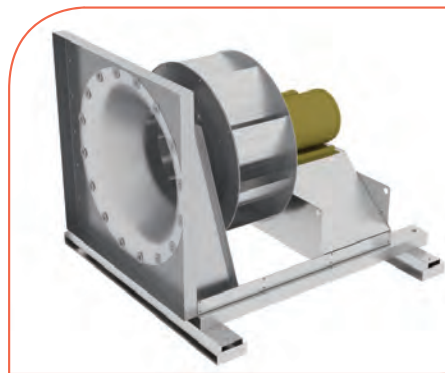

Indoor environmental quality options

- MERV 8-14 filters remove small particles from the air
- Pre- and post-filter options meet special application requirements
- Building pressure control
- Double-wall construction
- Low sound levels with eDrive™ plenum fan



Energy saving options

- Total-energy wheel with bypass dampers
- eDrive direct-drive, variable-speed plenum fan reduces drive losses and sound levels
- eFlex™ variable-speed compressor (available early 2013) delivers industry-leading AHRI-certified efficiency at all load levels



Support for CEE and LEED® projects

- CEE Tier 2 level performance for superior efficiency levels at all load conditions
- All aluminum microchannel condenser coil uses less refrigerant charge for reduced environmental impact (LEED EA credit 4) and improved corrosion resistance
- Fresh air management system (see above) for IEQ credit 1
- Additional filtration options (see above)

VariTrane™ terminal unit

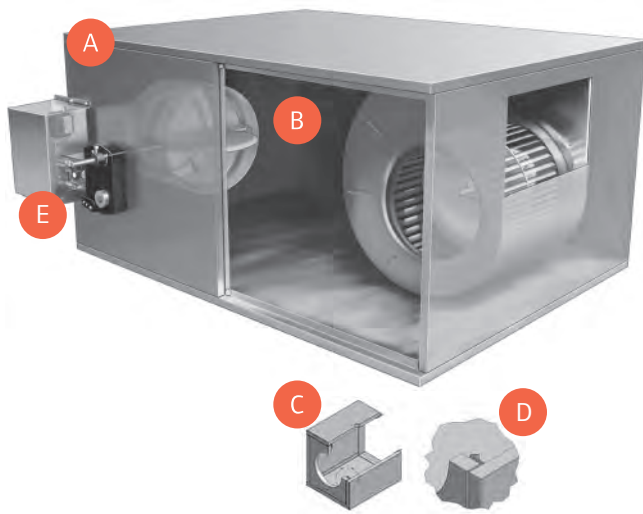

- A Trane flow ring for unmatched airflow measurement accuracy
- B Heavy gauge air valve cylinder for durability
- C Interlocking panels for extremely rugged construction
- D Insulation edges encapsulated with metal to prevent erosion into the air stream
- E Factory-commissioned DDC controls with pre-packaged sequences and wired or Wireless Comm

VariTrane units are manufactured in the most state-of-the-art VAV facility in the world. They feature proven components such as the patented Trane flow ring and the Trane DDC controller. The most advanced manufacturing techniques in the industry have been implemented to provide an exceptionally rugged and reliable VAV unit. All products are UL listed for safety and provide proven performance via accepted industry standards like AHRI 880 and 885.

All VariTrane VAV controls are factory commissioned. This means that airflow, temperature setpoints, and addressing are performed in a controlled factory environment. 100% factory run-testing ensures that units arrive and function properly upon job startup. With factory commissioned controls, you have better control over cost and quality. This results in a higher quality installation at a lower cost.

Single-duct and dual-duct air terminals

- Single-duct heat options include water or electric heating coils
- Unit sizes provide 0 to 8000 nominal CFM
- Access for water coil cleaning
- Factory-commissioned Trane controls
- Slip and drive connections as standard

Fan-powered air terminals

- Parallel intermittent fan and series continuous fan configurations
- Complete reheat options include water or electric heating coils
- Fan sizes provide 200 to 3000 nominal cfm
- Single-speed motor with SCR is standard for simplified system balancing
- Optional high-efficiency electrically commutated motors (ECMs)
- Low-height models for critical plenum requirements



Factory-commissioned controls

- Tracer™ UC210 or UC400 controller
- Temperature, airflow settings and addressing in a factory controlled setting
- Temperature and airflow setpoints downloaded and 100% run tested in the factory before shipment
- Wired or Wireless Comm



Accurate flow measurement

- Superior, exclusive flow ring for unmatched airflow measurement accuracy and unit performance
- Air valve designed to limit inlet deformation and provide consistent and repeatable airflow across the flow ring
- Enables auto-commissioning to ensure zone cooling and heating are precise and not wasteful
- Enables system ventilation optimization and proof of proper ventilation

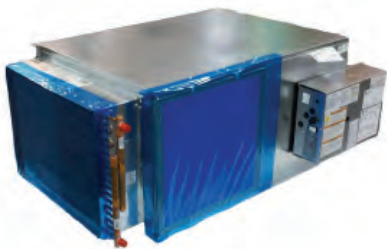

Low energy use, high indoor air quality

- Electrically commutated motor for series fan-powered terminals reduce energy use
- SCR option for continuously variable electric heating and precise temperature control
- Low casing and damper leakage and insulation deliver conditioning to the zone, not wasted in the ceiling plenum
- Insulation and encapsulated edges reduce or eliminate terminal unit surface condensation
- IAQ wrap protects unit during construction



Rugged construction and serviceability

- Remote auto-commissioning lets you fix problems without opening the ceiling and disturbing occupants
- Damper has only nine parts
- External shaft with air valve position indicator for easier service diagnostics
- Metal encapsulated edges arrest cut fibers and prevent insulation erosion into the air stream
- 18-gauge construction for strength, performance and durability

Pre-packaged equipment controls

Each equipment configuration comes with a control diagram, points list, and sequence of operation in document and CAD format. This makes it easy to develop accurate drawings and documentation for the system.

RTU control using the IntelliPak™ controller.

The Intelligent Variable Air System offers eighteen pre-packaged rooftop configurations, each supported by the IntelliPak controller.

IntelliPak controller with BCI-I interface

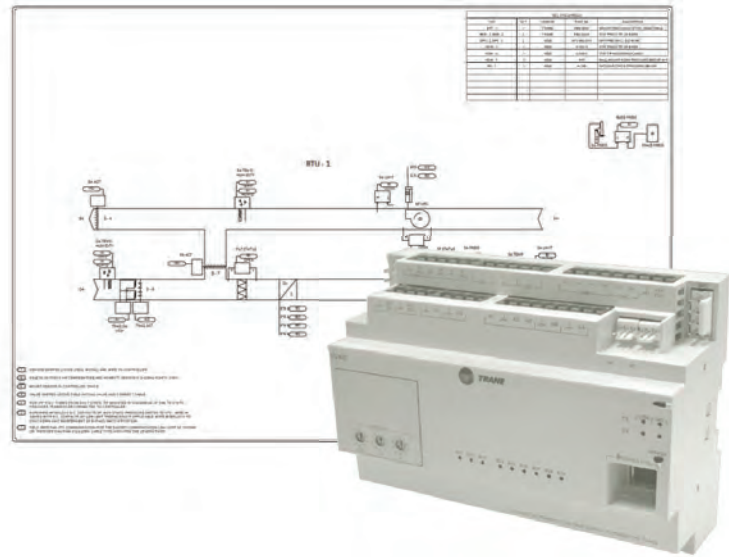

Pre-packaged rooftop control options

supported features						
pre-packaged solution	model	outdoor air damper	cooling type	heating type	secondary fan	energy recovery type
UN0241	IPAK I	Traq™	direct expansion	none	exhaust fan	none
UN0242	IPAK I	Traq	direct expansion	gas	exhaust fan	none
UN0243	IPAK I	Traq	direct expansion	electric	exhaust fan	none
UN0244	IPAK II	Traq	direct expansion	none	exhaust fan	none
UN0245	IPAK II	Traq	direct expansion	gas	exhaust fan	none
UN0246	IPAK II	Traq	direct expansion	electric	exhaust fan	none
UN0247	IPAK I	Traq	direct expansion	none	return fan	none
UN0248	IPAK I	Traq	direct expansion	gas	return fan	none
UN0249	IPAK I	Traq	direct expansion	electric	return fan	none
UN0250	IPAK II	Traq	direct expansion	none	return fan	none
UN0251	IPAK II	Traq	direct expansion	gas	return fan	none
UN0252	IPAK II	Traq	direct expansion	electric	return fan	none
UN0253	IPAK I	Traq	direct expansion	none	exhaust fan	total-energy wheel
UN0254	IPAK I	Traq	direct expansion	gas	exhaust fan	total-energy wheel
UN0255	IPAK I	Traq	direct expansion	electric	exhaust fan	total-energy wheel
UN0256	IPAK II	Traq	direct expansion	none	exhaust fan	total-energy wheel
UN0257	IPAK II	Traq	direct expansion	gas	exhaust fan	total-energy wheel
UN0258	IPAK II	Traq	direct expansion	electric	exhaust fan	total-energy wheel

VAV control using the UC210 or UC400.

The Intelligent Variable Air System offers nine pre-packaged VAV terminal configurations, each including programming code for the UC210 or UC400 controller.

Space temperature control functions are further refined, based on:

- the presence of a fan and/or a heating coil in the VAV terminal
- whether or not the zone is occupied
- whether the duct delivers cold or hot primary air
- whether or not the central unit is at minimum flow in the heating mode

Wireless controls. Trane Wireless Comm eliminates the wire between equipment and system controllers, and provides wireless connectivity to zone temperature sensors. The benefits include faster project completion, less disruption to building occupants, increased location flexibility, and life-cycle savings. Through use of self-healing wireless mesh, extended signal range, and conformance to the ZigBee™ Building Automation standard, Trane Wireless Comm provides reliable, expandable operation for the life of the building.

Pre-packaged VAV terminal control options

supported features			
pre-packaged solution	controller	terminal type	heating type
TS0155	UC210	single duct	none
TS0156	UC210	single duct	electric
TS0157	UC210	single duct	hot water
TS0158	UC210	parallel fan-powered VAV	none
TS0159	UC210	parallel fan-powered VAV	electric
TS0160	UC210	parallel fan-powered VAV	hot water
TS0161	UC210	series fan-powered VAV	none
TS0162	UC210	series fan-powered VAV	electric
TS0163	UC210	series fan-powered VAV	hot water
TS0043	UC400	single duct	none
TS0044	UC400	single duct	electric
TS0045	UC400	single duct	hot water
TS0046	UC400	parallel fan powered VAV	none
TS0047	UC400	parallel fan powered VAV	electric
TS0048	UC400	parallel fan powered VAV	hot water
TS0049	UC400	series fan powered VAV	none
TS0050	UC400	series fan powered VAV	electric
TS0051	UC400	series fan powered VAV	hot water

Trane Wireless Comm



Design Strategies

In addition to optimized controls, many intelligent Variable Air Systems make use of the following high-performance system design strategies to achieve even greater energy savings.

Exhaust air energy recovery

Air-to-air energy recovery refers to the transfer of sensible heat, or sensible heat and moisture (latent heat), between air streams. A common location from which to recover energy is the exhaust-air stream. The most common use of the recovered energy is for outdoor-air preconditioning.

Benefits of outdoor-air preconditioning.

- Reduces cooling, dehumidification, heating and humidification energy
- Allows downsizing of cooling, dehumidification, heating and humidification equipment

Best practices.

- Properly size the energy-recovery device
- Strive for balanced airflows
- Integrate with airside economizer operation
- Provide a means to control the capacity of the device at part load
- Provide a method for frost prevention in cold climates

The importance of proper control.

Coordinating with airside economizer cycle.

In many climates, an airside economizer can provide the benefits of “free” cooling for much of the year. While the economizer operates, air-to-air energy recovery offers no additional benefit. In fact, unless it is turned off, the total-energy wheel actually increases the cooling load by transferring heat from the exhaust air stream.

To accommodate economizer operation when the total-energy wheel is idle, bypass dampers allow full economizer airflow without significantly increasing the airside pressure drop.

Preventing frost. Any air-to-air energy-recovery device that preconditions outdoor air is subject to frost buildup during very cold weather. If the surface temperature of the device falls below the dew point of the exhaust air, water vapor will condense on the exhaust side of the device. If the exhaust-side surface temperature falls below 32°F, this water freezes, eventually blocking airflow. One of the benefits of total energy recovery over sensible-only energy recovery is that frost forms at a much colder outdoor temperature, which may even eliminate the need for frost prevention.

Typical approaches to frost prevention:

- Modulating an outdoor air bypass damper to reduce the heat-transfer capacity of the total-energy wheel, or
- Preheating either the outdoor or exhaust air before it enters the wheel, for applications with extremely cold outdoor air and higher indoor humidity levels during cold weather

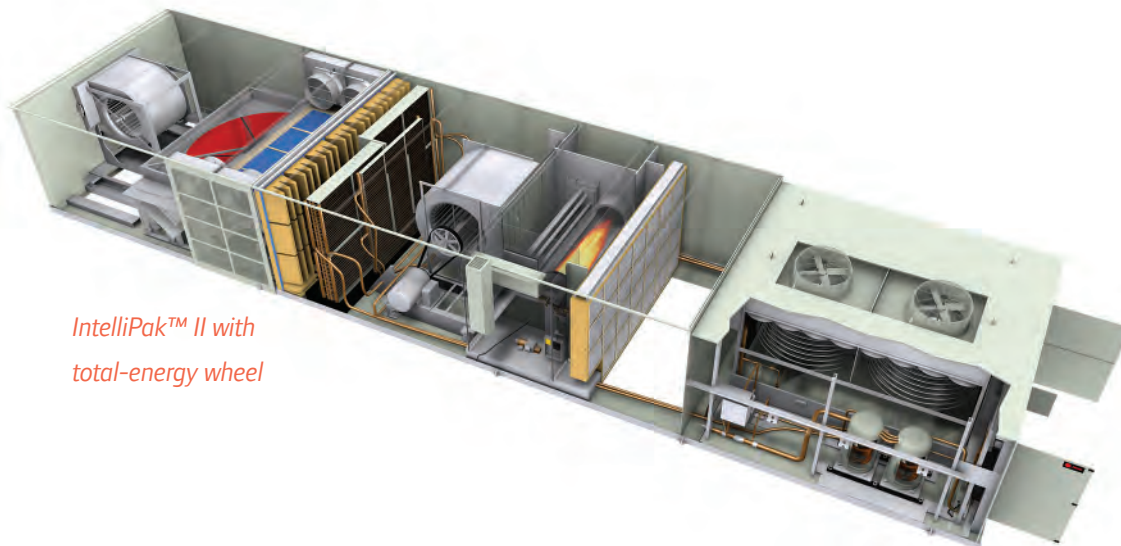

*IntelliPak™ II with
total-energy wheel*

Total-energy wheel offers an excellent combination of high (60 percent to 80 percent) total effectiveness ideally suited for hot and cold climates, where latent energy recovery in both the summer and winter seasons is desirable. Cross leakage is limited by choosing the right locations for supply and return or exhaust fans. In many applications and locations the total-energy wheel's higher levels of effectiveness may be required by the energy code.

Control of a total-energy wheel in a VAV system

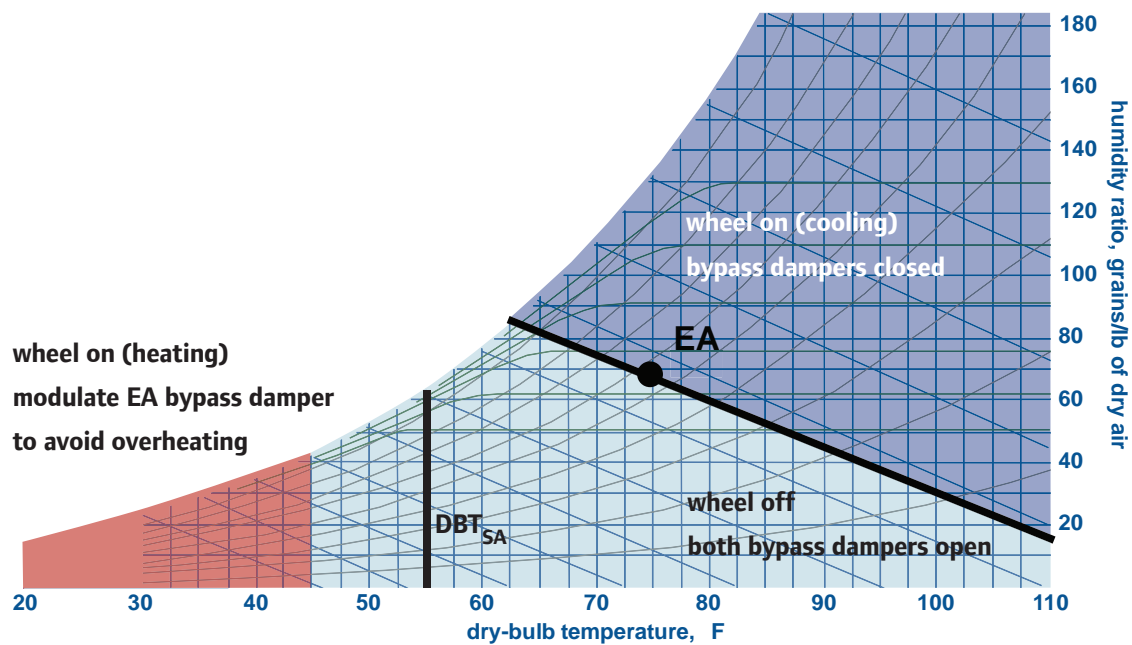

Cold-air distribution

Many choices in the design of an HVAC system are “predetermined” by experience. System design engineers repeatedly choose to supply 55°F air because they know it has worked in the past. The supply airflows that result from this choice directly impact the size (and cost) of fans, rooftop units, VAV terminal units, diffusers and ductwork. The size of fan motors is also affected, which extends the cost impact to the electrical distribution system.

An EarthWise™ Intelligent Variable Air System reexamines these rules of thumb for optimizing system performance and cost.

Cold-air VAV systems typically deliver supply air at a temperature of 45°F to 52°F. The appeal of cold-air distribution lies in the reduction of the airflow required to offset the sensible cooling loads in the zones. Lowering the supply-air temperature from 55°F to 50°F can reduce the supply-air volume by nearly 20 percent. In addition, the lower zone relative humidity that results from a cold-air system often allows the zone dry-bulb temperature to be slightly warmer than in a conventional system, while still remaining comfortable. The impact of these changes in the energy analysis results is identified on page 5.

Benefits of cold-air distribution. Reducing supply airflow triggers a series of related benefits:

- Smaller supply fan (and return or relief fan, if equipped)
- Smaller rooftop units and vertical air shafts, which can increase usable (or rentable) floor space
- Smaller VAV terminals, which ease tight installations, are less expensive, and may be quieter
- Smaller ductwork, which requires less sheet metal, simplifies installation, and leaves more space above the ceiling for other services
- Shorter floor-to-floor height (attributable to smaller ducts) may reduce the cost of glass and steel in a multistory building
- Smaller fan(s) reduce the cost of the electrical distribution system, lowers operating costs, and may reduce fan-generated noise
- Potential for lower space humidity levels due to the delivery of colder, drier air

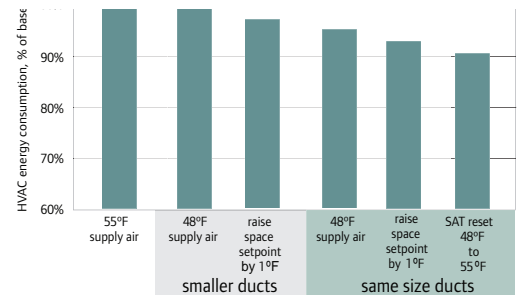

Challenges of cold-air distribution.

Concerns that design engineers have about cold-air distribution typically focus on the following three issues:

- Effects of delivering cold air into the zone on occupant comfort
- Avoiding condensation on components of the air distribution system
- Impact on overall system energy consumption

The first two challenges are overcome by selecting high-aspiration diffusers and/or fan-powered VAV terminals as air blenders, plenum returns, properly sealed and insulated components, and fully integrated system controls like those for this system. Whole building energy analysis quantifies the energy impact of operating a cold-air system, including the impact on airside economizer operation, cooling and heating plants, and fan-powered VAV terminals when present.

Parallel or series fan-powered VAV?

For air-blender applications, series fan-powered VAV terminals are often preferred for large conference rooms or other zones where constant airflow is desirable. Parallel fan-powered VAV terminals (with constant fan operation during occupied periods) are well suited for zones where less air motion during off-peak conditions is acceptable.

Duct design best practices

Attention to detail in duct design makes an enormous impact on the overall performance of the system. Once you've reduced the airflow by investigating using colder than traditional air for cooling, the next challenge is to design the ductwork in a way that doesn't waste energy or drive up the installed costs.

One of the keys to high performance ductwork at an affordable cost is to use spiral (round) ducts.

Minimize leakage. It is almost impossible to get below 3 percent leakage with rectangular duct designs, while it is possible to get below 1 percent leakage with spiral duct. This ensures that the energy created by the system actually conditions the zones. Spiral duct transitions and connections can be easily sealed using gaskets and sealant, rather than couplings and screws, and perform at seal class A with leakage class 6. The rooftop units and VAV terminals have low leakage, so it makes sense for the connecting ducts to perform at the same level.

Furthermore, the model energy codes require pressure testing of entire sections of installed ductwork once the system gets above 750 Pa (3" w.g.) Using factory-built spiral duct gives you added assurance that your system's tightness isn't at the mercy of the skill and attention to detail of the sheet metal installer in order to pass the leakage test.

Minimize fitting losses. Another way to limit energy waste is to use high efficiency fittings. Spiral duct fittings have lower losses, so you can more efficiently move air at higher speeds through the duct system.

Reduce duct heat pickup. Spiral duct has less surface area for the same cross sectional area (lower aspect ratio) than rectangular duct. This limits the exposure of conditioned air surfaces and reduces duct heat pickup.

Advantages of static regain duct design.

Now that the advantages of spiral duct have been identified, take it one step further and use the final advantage of spiral duct—its rigidity—to unlock the last two benefits: minimizing space and reducing cost. This rigidity and the ability of spiral duct to resist the "oil can" effect at high velocities leads designers to static regain duct design calculations made possible by the use of software such as VariTrane™ Duct Designer.

Minimize space needed for ductwork. High velocity duct systems use less space to deliver conditioning, with even less sheet metal than high aspect ratio rectangular ducts. Smaller spiral ducts can be used for the equivalent cooling capacity, and their performance is not degraded at high velocities like rectangular ducts.

Reduce cost. Higher velocity spiral duct systems dramatically reduce the sheet metal content and installation costs.



Design resources

Pre-packaged Solutions (PPS)

PPS information can be found at
www.traneengineer.com

Each pre-packaged solution includes:

- Sequence of operation
- I/O summary (points list)
- Flow sketch
- Control drawing
- Controller wiring detail
- End device details

Pre-built RTU graphics



Control drawings

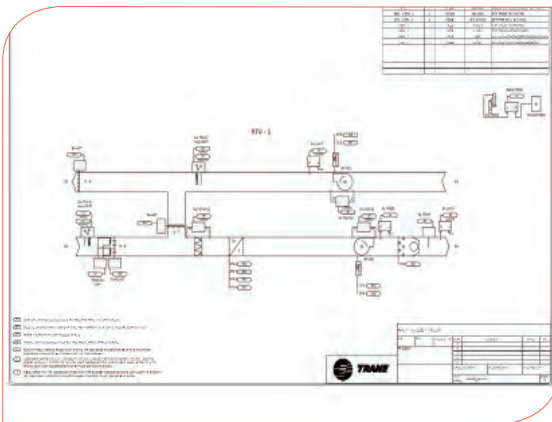

I/O point summaries

UN0050 - SYSTEM POINT LIST										
CONTROLLER: INTELLIPAK		POINT TYPE				ALARMS				
SYSTEM POINT DESCRIPTION										
RTU VAV: IntelliPak I (BCI) DX CLC Gas Heat, Cool and Exhaust Fan (with Dehumidification)										
SYSTEM POINT DESCRIPTION	UNITS	ANALOG INPUT	ANALOG OUTPUT	DEFAULT VALUE	HEATING MODE LIMIT	COOLING MODE LIMIT	LA TECH/CONTROL	SENSOR FAIL	COMMUNICATION	REFERENCE
ZONE SENSOR	ZONE TEMPERATURE (THERM)	X								SENSOR FAILURE
	ZONE TEMPERATURE SETPOINT								X	SENSOR FAILURE
	ON/CANCEL									NOTE 1
	OUTDOOR AIR TEMPERATURE	X								SENSOR FAILURE
	OUTDOOR AIR HUMIDITY	X			X	X				SENSOR FAILURE
	OUTSIDE AIR DAMPER TRAQVCM	X			X	X				SENSOR FAILURE
	HEATING MODE SETPOINT	X			X					
	COOLING MODE SETPOINT	X			X					
	RETURN AIR TEMPERATURE				X	X				SENSOR FAILURE
	RETURN AIR HUMIDITY				X	X				SENSOR FAILURE
	RETURN AIR COOL				X	X				SENSOR FAILURE
	DISCHARGE AIR TEMPERATURE				X	X				SENSOR FAILURE
	DISCHARGE AIR TEMPERATURE SETPOINT									
	ECONOMIZER DAMPER POSITION									
	ECONOMIZER MINIMUM POSITION				X					
	BUILDING STATIC PRESSURE				X	X				SENSOR FAILURE
	SUPPLY AIR PRESSURE				X	X				SENSOR FAILURE
	SUPPLY AIR PRESSURE SETPOINT				X					
	UNIT STATUS									
	DIRTY FILTER									

Sequences of operation

TRANE Issue Date: 5-10-2012 Supersedes: 5-25-2011

Project: IntelliPak VAV Rooftop with Gas Heat and Exhaust Fan PPS System: UN0050 Page: 1 of 2

Contractor: BCI Company: Pre-Packaged Solutions Team Document to be Made: UN0050 Sequence, EN, etc.

Sequence of Operations:
 IntelliPak VAV Rooftop Unit with BCI Controller
 Cooling with Gas Heat, Exhaust Fan, and Traq Dampers

Building Automation System Interface:
 The Building Automation System (BAS) will send the RTU controller Occupied, Unoccupied, Morning Warm-Up / Cool-Down, Unoccupied Heat/Cool, and Reset Override commands. The BAS will also send the RTU controller a discharge air temperature setpoint, a duct static pressure setpoint, and an outdoor air flow setpoint, each calculated to optimize on runtime in the BAS. If communication is lost with the BAS, the RTU controller will operate using its local schedule and default setpoints.

Unoccupied Mode:
 When the unoccupied mode the supply and exhaust fans will be turned off, the compressors and gas heat will be turned off, the outdoor air (OA) damper will be closed, and the return air (RA) damper will remain open.

The rooftop unit (RTU) will cycle on, as directed by the BAS, to maintain the adjustable (set) unoccupied space heating and cooling setpoints. The supply fan variable frequency drive (VFD) will operate and modulate to maintain duct static pressure at setpoint (set). The compressors or gas heat will cycle to maintain discharge air temperature at setpoint (set). The OA damper will remain closed, the RA damper will remain closed, the RA damper will remain closed, and the exhaust fan will remain off (except for during an unoccupied economizing mode).

Morning Warm-Up Mode:
 On a transition from the unoccupied mode to occupied mode, if the average zone temperature is below the occupied heating setpoint a morning warm-up mode will be activated. When morning warm-up is initiated, the RTU will operate the supply fan and gas heat. The supply fan VFD will modulate to maintain duct static pressure at setpoint (set). The gas heat will modulate to maintain discharge air temperature at setpoint (set). The OA damper will remain off. The OA damper will remain closed, the RA damper will remain open, and the exhaust fan will remain off (except for during an unoccupied economizing mode). When the average zone temperature reaches the occupied heating setpoint (set), the RTU will transition to the occupied mode.

Morning Cool-Down Mode:
 On a transition from the unoccupied mode to occupied mode, if the average zone temperature is above the occupied cooling setpoint a morning cool-down mode will be activated. When morning cool-down is initiated, the RTU will operate the supply fan and DX cooling. The supply fan VFD will modulate to maintain duct static pressure at setpoint (set). The DX cooling will cycle to maintain discharge air temperature at setpoint (set). The gas heat will remain off. The OA damper will remain closed, the RA damper will remain open, and the exhaust fan will remain off (except for during an unoccupied economizing mode). When the average zone temperature reaches the occupied cooling setpoint (set), the RTU will transition to the occupied mode.

If the BAS indicates that outdoor conditions are suitable for unoccupied economizing, the RTU will enable the supply and exhaust fans, open the OA damper, and close the RA damper. The supply fan VFD will modulate to maintain duct static pressure at setpoint (set). The exhaust fan VFD will modulate to maintain building pressure at setpoint (set). The compressors and gas heat will remain off.

Occupied Mode:
 In the occupied mode, the supply fan VFD will operate continuously and modulate to maintain duct static pressure at setpoint (set). The

System control diagram for specific configuration

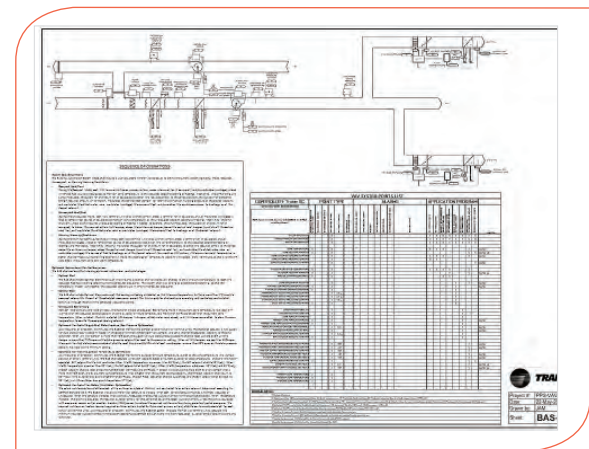

Design tools and educational resources

Application Engineering manual



CAD and BIM drawing files

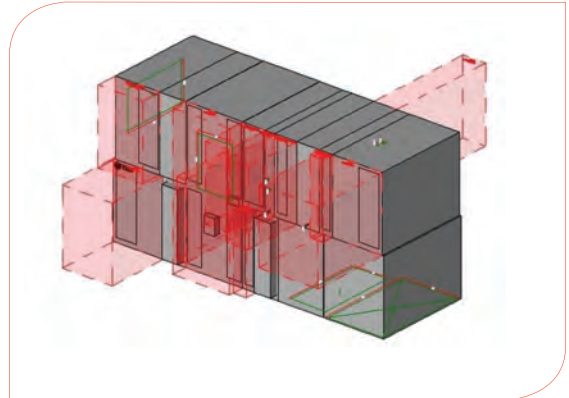

VariTrane™ Duct Designer software and support

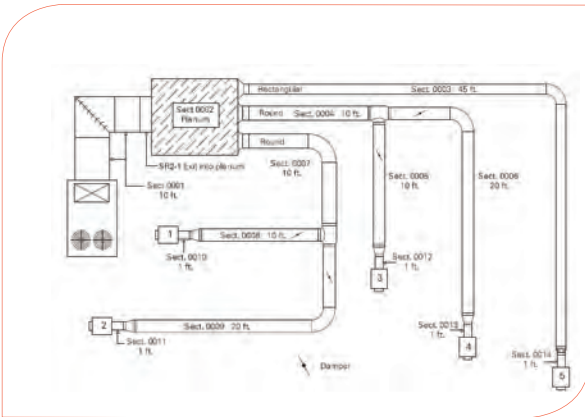

TRACE™ energy and economic software and support

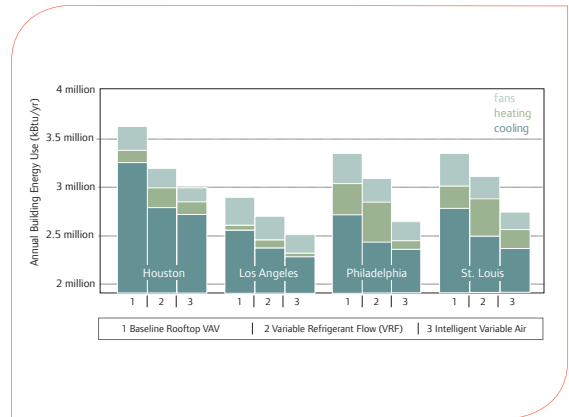

Engineers Newsletter Live DVD and on-demand programs



Fast, simple retrofits



Don't let your existing control system limit the performance of your building. Upgrading an existing system to a Trane Intelligent Variable Air system can be a fast, trouble-free process. Wireless technology, retrofit dampers and pre-packaged controls reduce installation cost, time and inconvenience to building occupants—and Trane Wireless Comm means less disruptive wiring installation, making future building changes easier.

Retrofit VAV dampers. The Round-in/Round-out (RI/RO) VAV unit is a retrofit product designed to simplify upgrading existing, older VAV terminal units, or to upgrade existing constant volume systems to VAV systems. Relay kits allow the existing heating coil and/or fan to be reused; only the controls and damper are changed. These retrofit dampers are particularly well-suited for upgrading old pneumatic or non-communicating electronic controls to a data-rich, communicating DDC VAV system. Your old VAV system can become a high-performance, Intelligent Variable Air system with minimal occupant disruption.

Wireless controls. Trane Wireless Comm eliminates the wire between equipment and system controllers, and between equipment controllers and zone sensors, for faster project completion, less disruption to building occupants, increased location flexibility, and life-cycle savings. Wireless mesh, maximum range, and conformance to the ZigBee™ Building Automation standard provide reliable, expandable operation for the life of the building.



Retrofit RI/RO damper installed in upstream duct



Retrofit RI/RO damper bolted to existing terminal



Wireless zone sensors

Upgrading existing controls to an Intelligent Variable Air System

existing VAV box controls			
controller type	communication protocol	Trane controller	upgrade Trane controller
pneumatic	N/A	PVR	UC210 or UC400 VAV retrofit kit with WCI
analog electric	N/A	electric	UC210 or UC400 VAV retrofit kit with WCI
DDC (Trane)	Comm3	VAV I	UC210 or UC400 VAV retrofit kit with or without WCI ¹
	Comm4	VAV II or III	UC210 or UC400 VAV retrofit kit with or without WCI ²
	LonTalk™	VV550/551	Keep existing VAV box controllers, or Upgrade with UC210 or UC400 VAV retrofit kit and WCI ³
DDC (non-Trane)	N/A	N/A	UC210 or UC400 VAV retrofit kit with WCI

existing RTU controls			
controller type	communication protocol	Trane controller	upgrade Trane controller ⁴
DDC (Trane)	Comm4	IntelliPak TCI	IntelliPak BCI-I with or without WCI ²
	LonTalk™	IntelliPak LCI-I	Keep existing RTU controller, or Upgrade with IntelliPak BCI-I and WCI ³
	Comm4	Voyager Commercial TCI	Voyager Commercial BCI-R with or without WCI ²
	LonTalk™	Voyager Commercial LCI-R	Keep existing RTU controller, or Upgrade with Voyager Commercial BCI-R and WCI ³
DDC (non-Trane)	N/A	N/A	UC600 with WCI

1. Trane Comm3 wire specifications are equivalent to Trane BACnet MSTP, so existing Comm3 wiring could be reused. Alternatively, a Wireless Comm upgrade is possible by using WCIs.
2. Trane Comm4 wire specifications are equivalent to Trane BACnet MSTP, so existing Comm4 wiring could be reused. Alternatively, a Wireless Comm upgrade is possible by using WCIs.
3. Tracer SC system controller is compatible with LonTalk communications, so existing LonTalk controllers and wiring could be reused. Alternatively, the equipment controllers could be upgraded using Wireless Comm.
4. In order to make use of the Ventilation Optimization functionality in Tracer SC, the air-handling unit or rooftop unit needs to be equipped with Traq™ outdoor airflow measurement.

BCI-I = BACnet™ Communication Interface for IntelliPak™

BCI-R = BACnet™ Communication Interface for ReliaTel™

LCI-I = LonTalk™ Communication Interface for IntelliPak™

LCI-R = LonTalk™ Communication Interface for ReliaTel™

PVR = Pneumatic Volume Regulator

TCI = Trane Communication Interface

WCI = Wireless Communication Interface



Ingersoll Rand (NYSE:IR) is a world leader in creating and sustaining safe, comfortable and efficient environments in commercial, residential and industrial markets. Our people and our family of brands—including Club Car®, Ingersoll Rand®, Schlage®, Thermo King® and Trane®—work together to enhance the quality and comfort of air in homes and buildings, transport and protect food and perishables, secure homes and commercial properties, and increase industrial productivity and efficiency. We are a \$14 billion global business committed to sustainable business practices within our company and for our customers. For more information, visit www.ingersollrand.com.